

# WPC DOORS



**ALM PLUS**

Quality That Lasts. Innovation That Leads





**WPC Doors** are made by mechanized manufacturing process, which offers uniform thickness without undulation, warping or bending and a smooth surface for lamination's.

It offers dimensional accuracy and stability in varying humidity and has a high screw holding capacity, high shock and buckling resistance.

Unlike natural wood, WPC is mainly made up of wood compound and plastic that has gone through certain processes which have wood alike finishing.

the beauty of wood and durable synthetic materials. without cellulose which is found in most plants (wood) thus WPC is not appetizing to termites.

WPC boards have more internal strength, weight and above all no tress are cut in their production.



# ■ Products

## Special features

- WPC doors have good flame retardant performance
- Moisture proof
- Colorful variety of appearance and long service life
- Resistant to chemicals and corrosion
- WPC doors are durable and have long service life, and very nice appearance



# ELITE

## GROUP DOORS



COVER P.V.C



**CD53**

CONCRETE



**CD40**

WALNUT



**D39**

RED WALNUT



**CD515**

MID OAK



**CD56**

GOLDEN OAK



**CD17**

LIGHT ACACIA



**CD43**

WHITE



**CD48**

LIGHT WALNUT



**CD12**

DARK OAK



WaterProof



Self-Extinguishing



AntiBacterial



Sound Insulation



High Strength



Eco-Friendly

# ELITE

## PALLET DOORS



**CD43**

WHITE



**CD53**

CONCRETE



**CD12**

DARK OAK



**CD56**

GOLDEN OAK

# C.N.C

## GROUP DOORS



COVER P.V.C



**CD53**

CONCRETE



**CD40**

WALNUT



**D39**

RED WALNUT



**CD515**

MID OAK



**CD56**

GOLDEN OAK



**CD17**

LIGHT ACACIA



**CD43**

WHITE



**CD48**

LIGHT WALNUT



**CD12**

DARK OAK



WaterProof



Self-Extinguishing



AntiBacterial



Sound Insulation



High Strength



Eco-Friendly

# C.N.C

## PALLET DOORS



**CD43**

WHITE



**CD53**

CONCRETE



**CD12**

DARK OAK



**CD56**

GOLDEN OAK

# FRAME GLASS

## GROUP DOORS



COVER P.V.C



**CD53**

CONCRETE



**CD40**

WALNUT



**D39**

RED WALNUT



**CD515**

MID OAK



**CD56**

GOLDEN OAK



**CD17**

LIGHT ACACIA



**CD43**

WHITE



**CD48**

LIGHT WALNUT



**CD12**

DARK OAK



WaterProof



Self-Extinguishing



AntiBacterial



Sound Insulation



High Strength



Eco-Friendly

# FRAME GLASS

## PALLET DOORS



**CD43**

WHITE

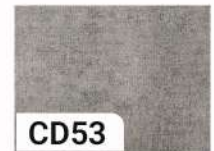

**CD53**

CONCRETE



**CD12**

DARK OAK



**CD56**

GOLDEN OAK

# LINE PLEXI

## GROUP DOORS



COVER P.V.C



**CD53**

CONCRETE



**CD40**

WALNUT



**D39**

RED WALNUT



**CD515**

MID OAK



**CD56**

GOLDEN OAK



**CD17**

LIGHT ACACIA



**CD43**

WHITE



**CD48**

LIGHT WALNUT



**CD12**

DARK OAK



WaterProof



Self-Extinguishing



AntiBacterial



Sound Insulation



High Strength



Eco-Friendly

# LINE PLEXI

## PALLET DOORS



**CD43**

WHITE



**CD53**

CONCRETE



**CD12**

DARK OAK



**CD56**

GOLDEN OAK

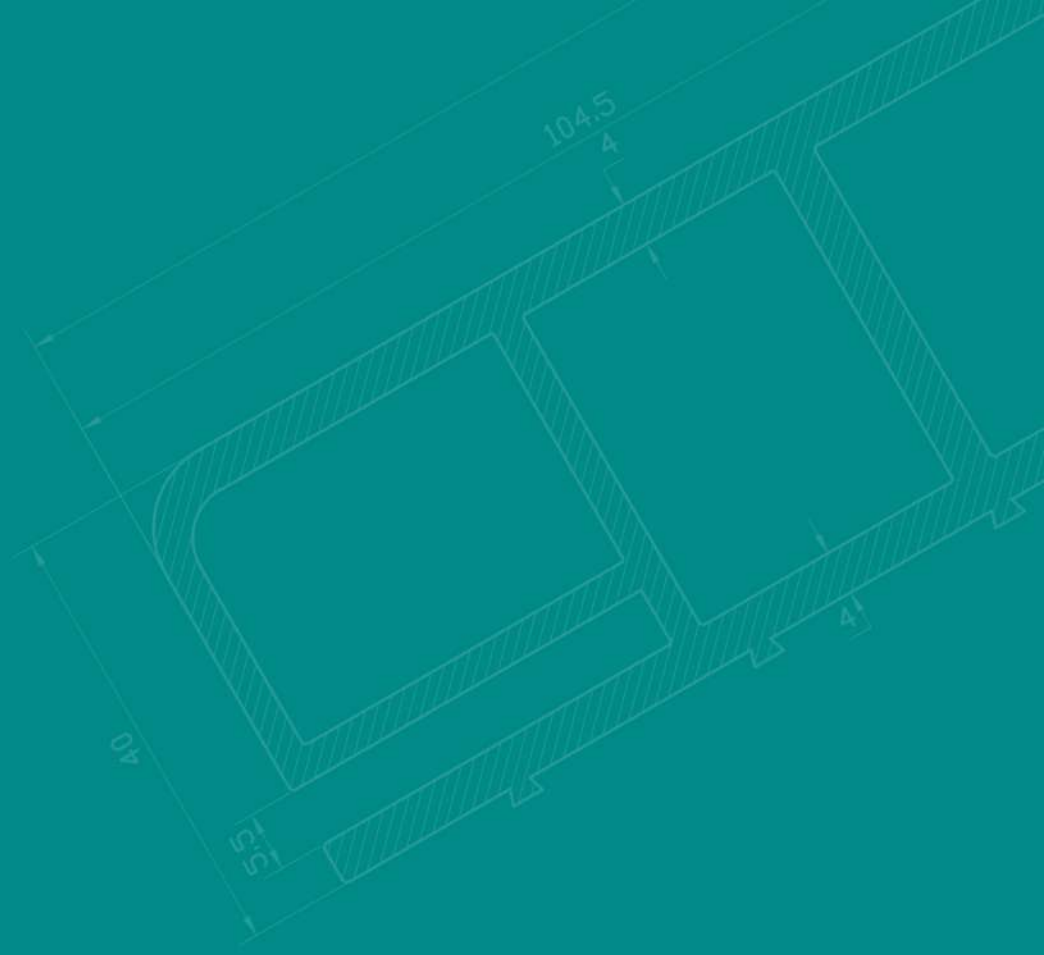

# ■ Structure

# ALM PLUS

Quality That Lasts. Innovation That Leads

## MODERN FRAME 120mm



## REBATE FRAME 120mm

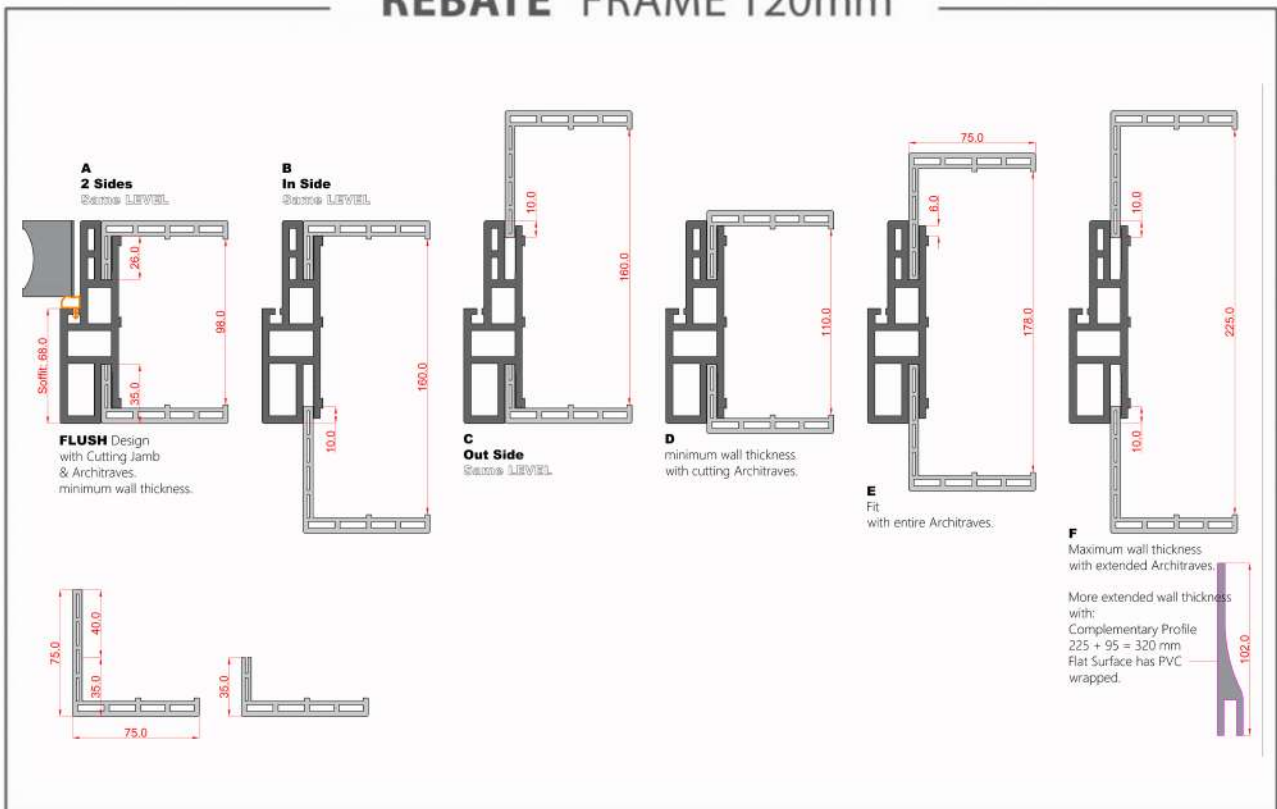

# ALM PLUS

Quality That Lasts. Innovation That Leads

## MODERN FRAME 180mm



## REBATE FRAME 180mm

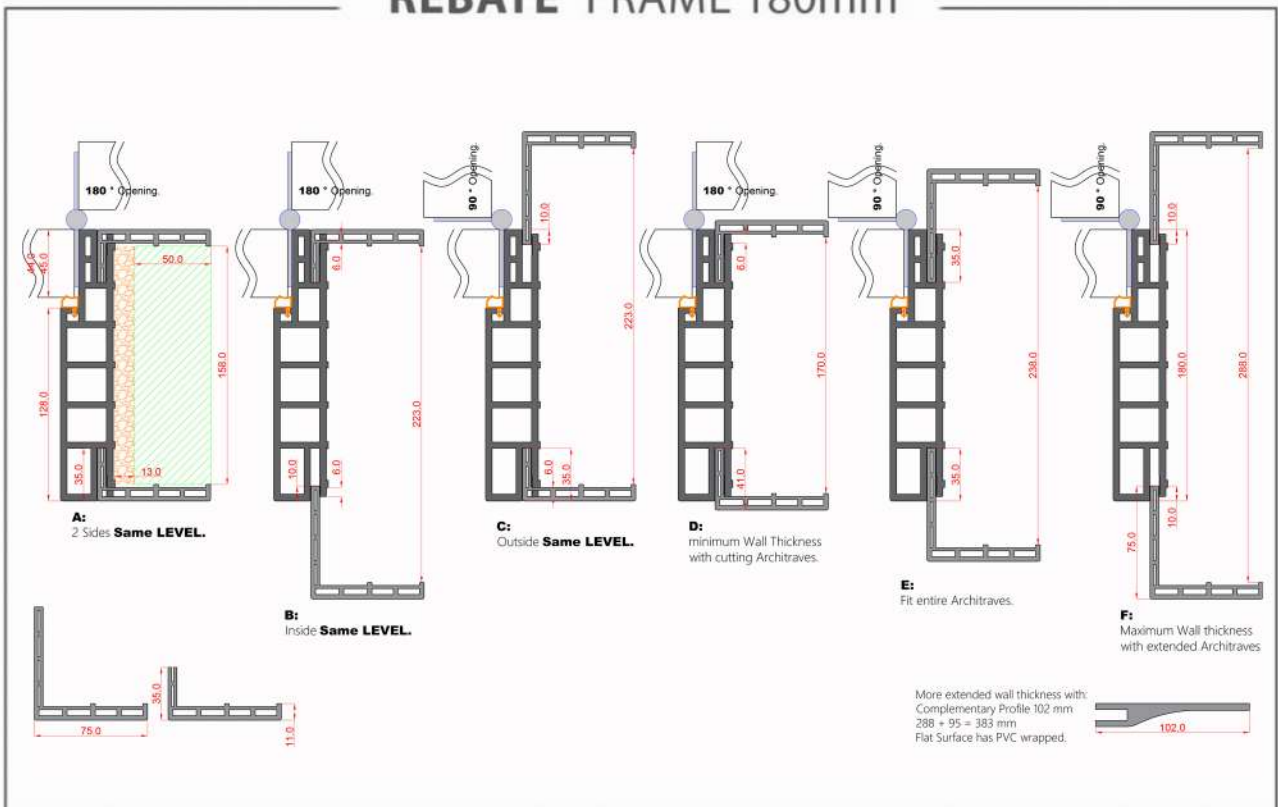

# ALM PLUS

Quality That Lasts. Innovation That Leads

## MODERN FRAME 240mm

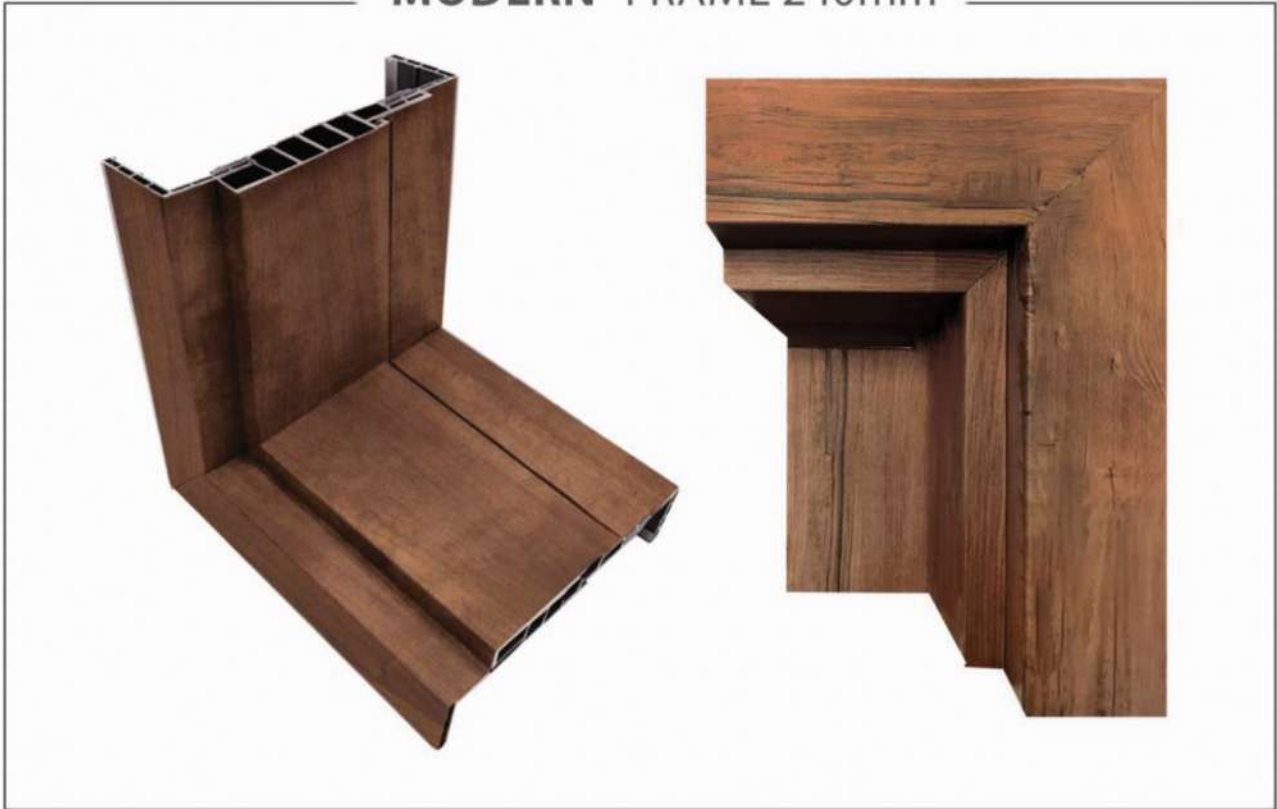

## REBATE FRAME 240mm

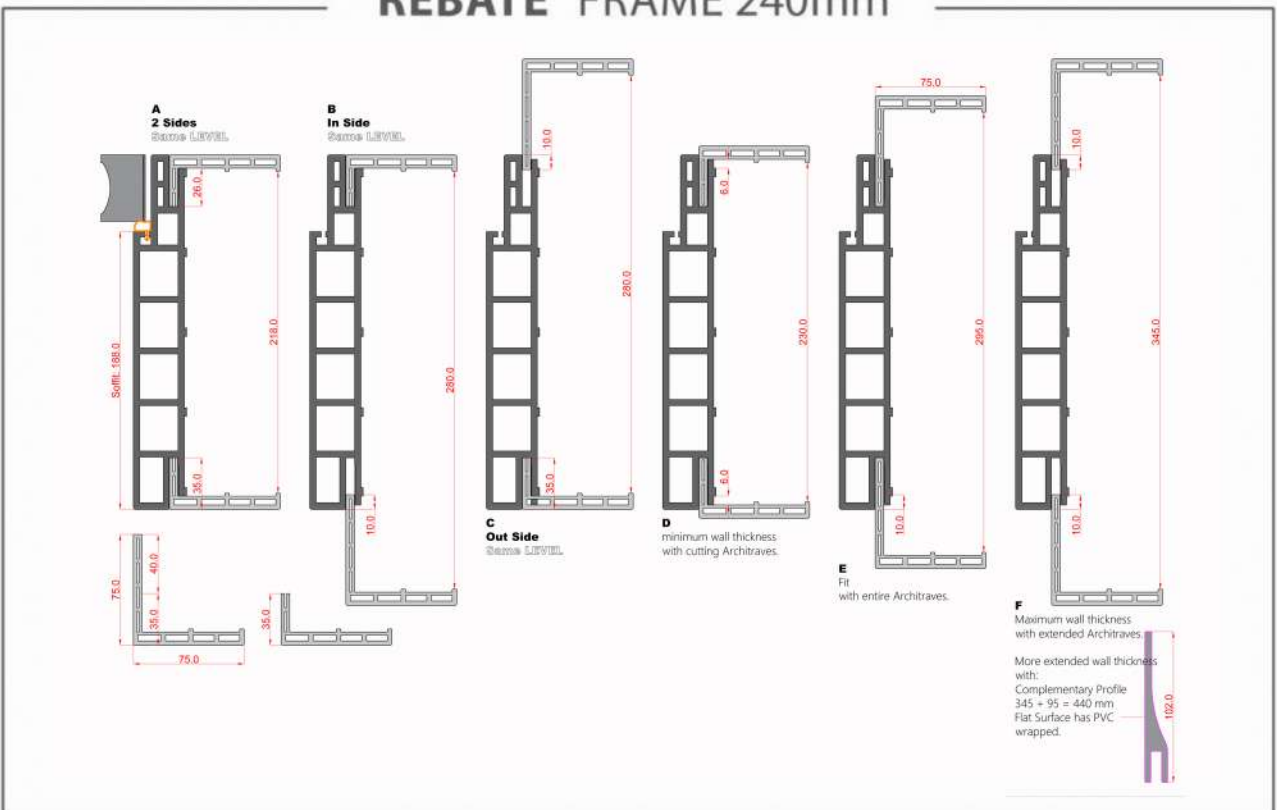

# ALM PLUS

Quality That Lasts. Innovation That Leads

## WPC Luxury Frame 120

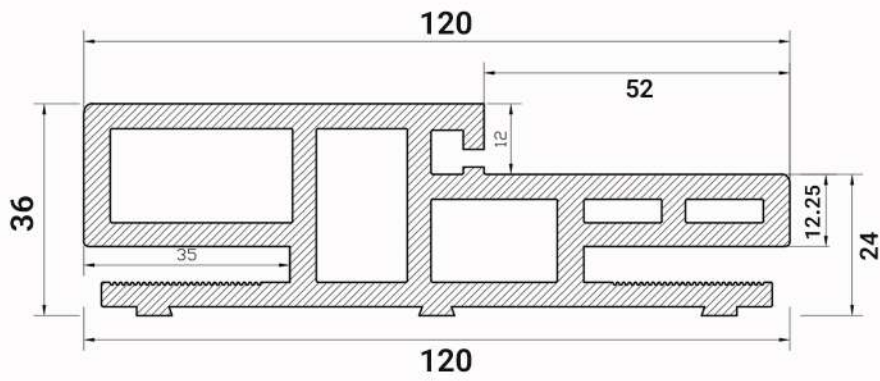

## WPC Luxury Frame 180

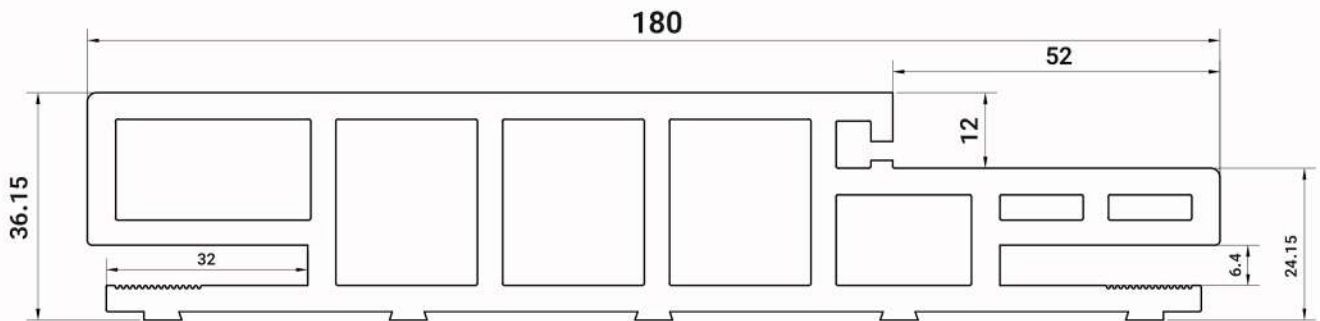

## WPC Luxury Frame 240

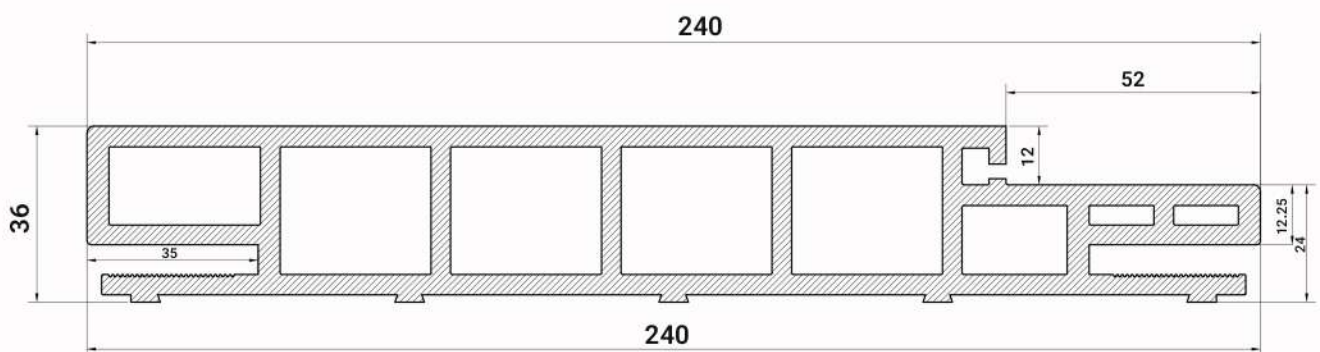

# ALM PLUS

Quality That Lasts. Innovation That Leads

## INSTALLATION SITE REQUIREMENTS

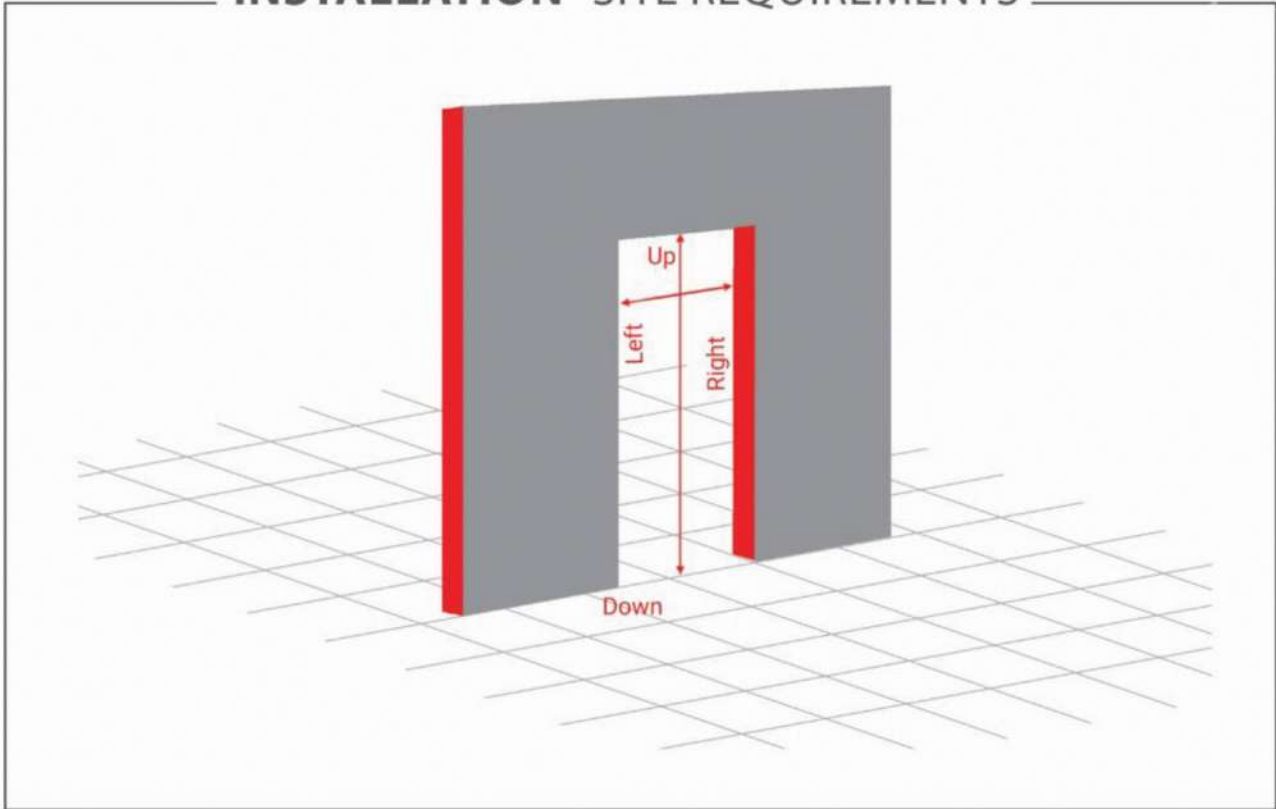

## INSTALLATION SITE REQUIREMENTS



# ALM PLUS

Quality That Lasts. Innovation That Leads

## STRUCTURE INSIDE DOOR

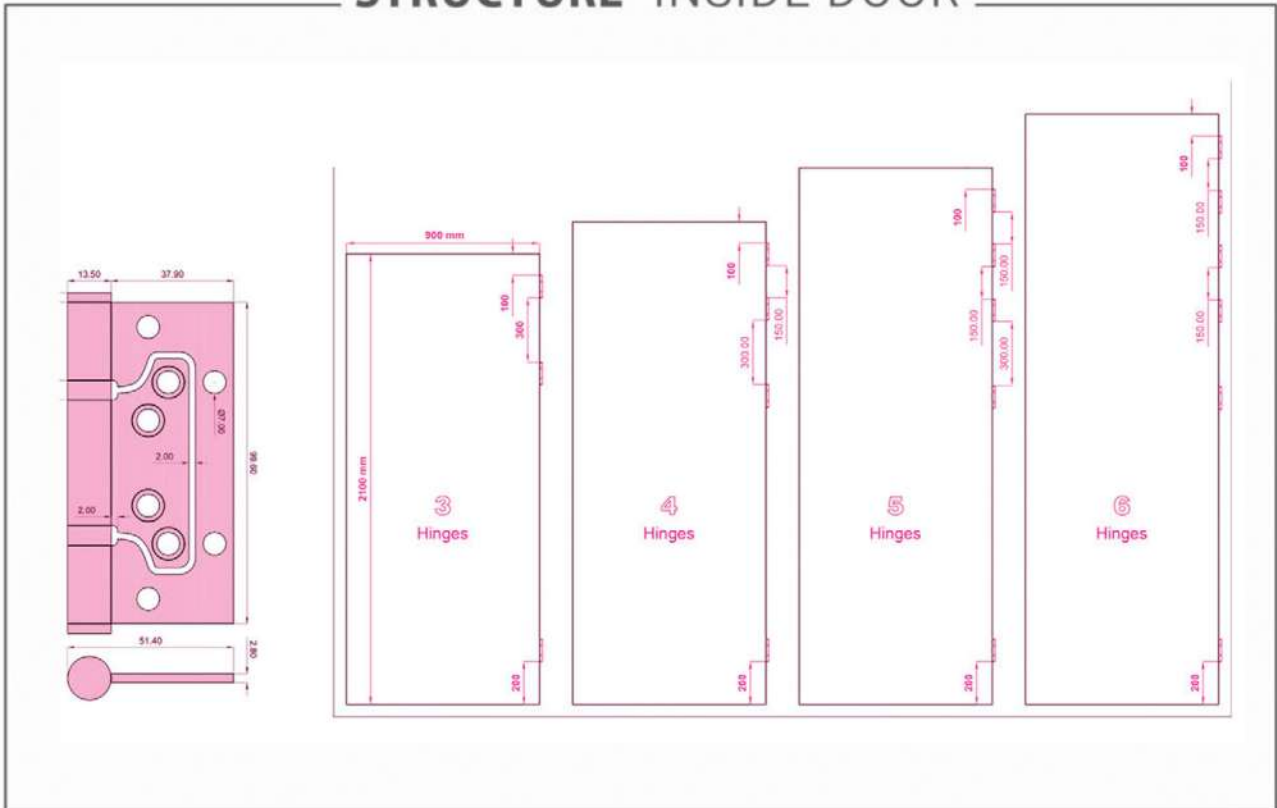

## SAME LEVEL DOOR PLAN TECHNICAL

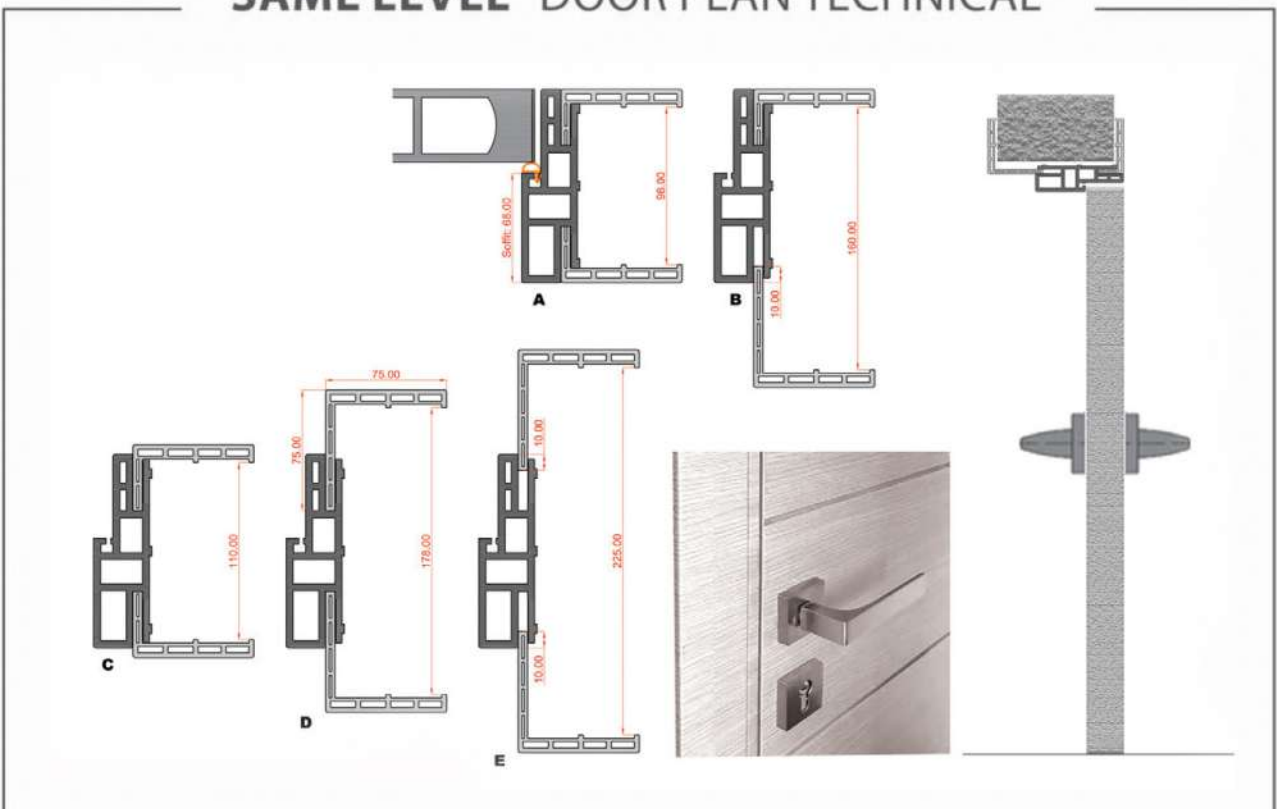

# ALM PLUS

Quality That Lasts. Innovation That Leads

## DIAGRAM SHOWING

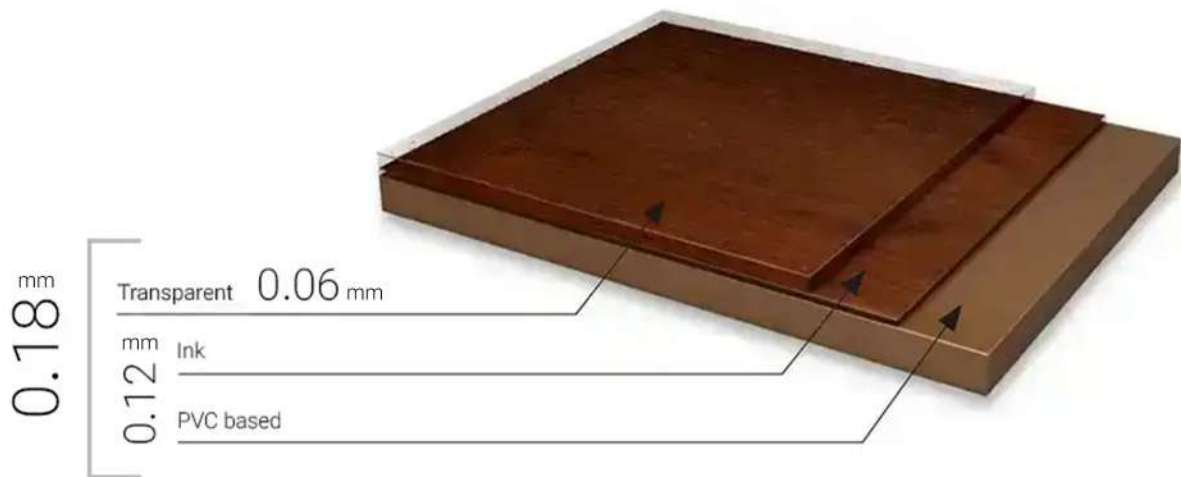



**Contact us:**

 ALM Plus, P.O Box 53023, Abu Dhabi, UAE

 [www.almplus.com](http://www.almplus.com)  [info@almplus.com](mailto:info@almplus.com)